



DS-1697ZJ

Anticorrosive Wall Mounting Bracket

Features:

- Stainless steel 316L material
- Anti-corrosion design for adverse environment
- Design of safety rope for more convenient installation

Dimension:

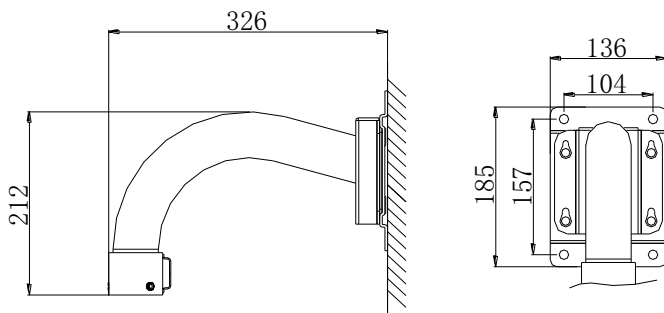

Order Model:

DS-1697ZJ

Parameter:

Model	DS-1697ZJ
Parameter	Anticorrosive wall Mounting Bracket
Range of Application	For speed dome wall mounting
Material	Stainless steel 316L
Dimension	136×212×326mm
Weight	2300g

Notice:

- The bracket should be installed on flat wall
- Load capacity of pole should be more than 3 times the weight of camera and bracket
- Load capacity of clamp is 15KG

Installation steps:

- ① Choose the appropriate wall and paste the template of pre-installed plate

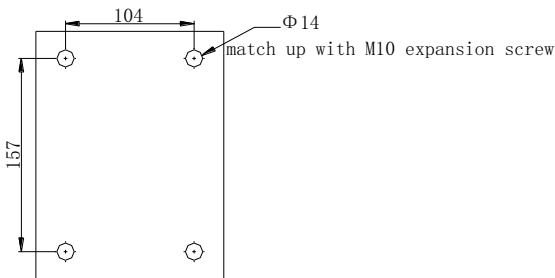

- ② Drill the Screw holes and twist the expansion bolts

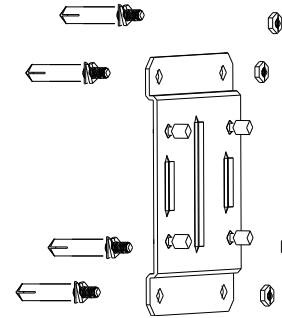

- ③ Fix the pre-installed plate

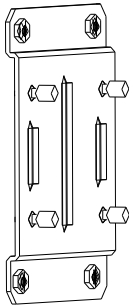

- ④ Install the bracket to the pre-installed plate

